

# BED

Jasper Morrison

cappellini



Bed with frame in solid fir, poplar plywood and metal frame, staves in beech plywood; padding in multi-density polyurethane foam. Removable cover in fabrics and leathers of the collection. Also available an additional removable cover in Pelle Ovo, Tela Bianca or Tela Forte, short for feet at sight or with flounce.

## Materials used\_

### Structure:

Massive fir, poplar plywood, metal frame

### Padding:

Multi-density polyurethane foam

### Main bedsead:

Ash plywood slats

### Base:

Polish natural aluminium

### Feet:

Adjustable central feet in black varnished metal

### Cover:

Removable in fabric, leather G, leather G2

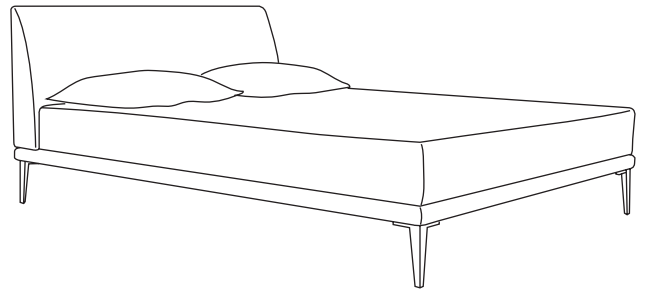

## Dimensions\_

### NB\_120

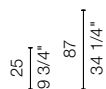
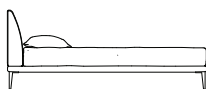
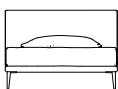
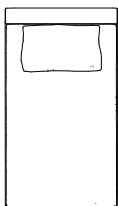

123  
48 1/2"

220  
86 1/2"

### NB\_152

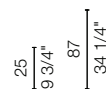
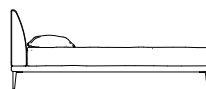
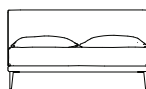
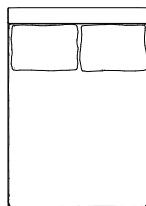

155  
61"

220  
86 1/2"

**NB\_160**

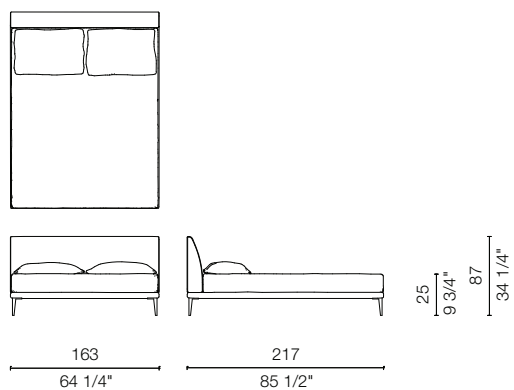

**NB\_170**

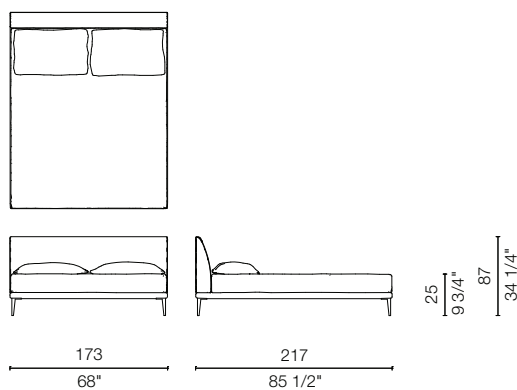

**NB\_180**

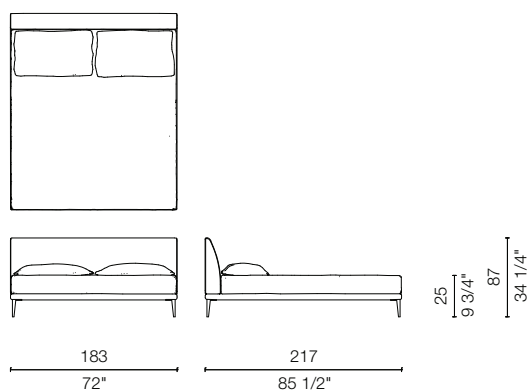

**NB\_193**

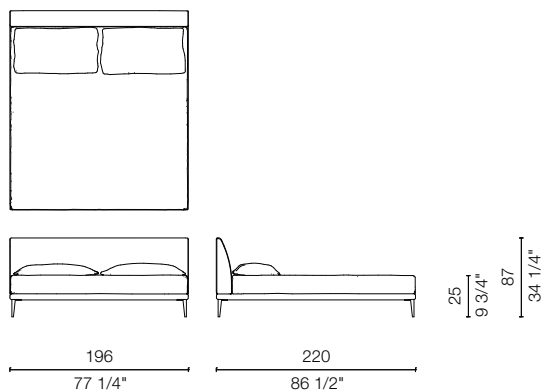

**NB\_200**

