



Series of cabinets for the living area, characterized by a great visual lightness. Available veneered or matt or polish lacquered, completed with different closing tops: lacquered, veneered, marble or lacquered crystal.

Used materials

Case:

1. Wood particles panels, melamine plated, matt or glossy lacquered, colours as per price list or veneered in natural or wenge-stained or walnut-stained oak, teak or canaletto walnut, transparent painted.

Doors:

2. Wood particles panels melamine plated, in the same finish as the case.
3. Snap hinges in satin steel with decelerating clamping device.

Drawers:

4. Drawer fronts in wood particles panels in the case finishes, with metal rails for drawer sliding.
Drawers structure made of wood particles panels covered with melamine, desert colour.

Flap doors:

5. Wood particles panels in the same finish of the case, opening with Winch mechanism.

Glass container:

6. Box with a drawn-aluminium structure, 4 mm glass sheets and wood particles panels in the colour of the cases.

Open compartment:

7. Back panel and top panel in medium fiber conglomerate, in the finish of the cases.
8. Internal dividers made of medium fiber conglomerate in the finish of the cases, with metal rod inner structure.

Closing top:

9. Lacquered or veneered wood particles panels, or marble slab, or rear-lacquered glass.

Base panel:

10. Lacquered or veneered wood particles panels.

Metal base:

11. Metal base anthracite matt epoxy coated with adjustable black plastic feet, h. 16 cm.

Handles:

12. Push-pull mechanism, or steel knob, lacquered on the front, with relief-work on the side.

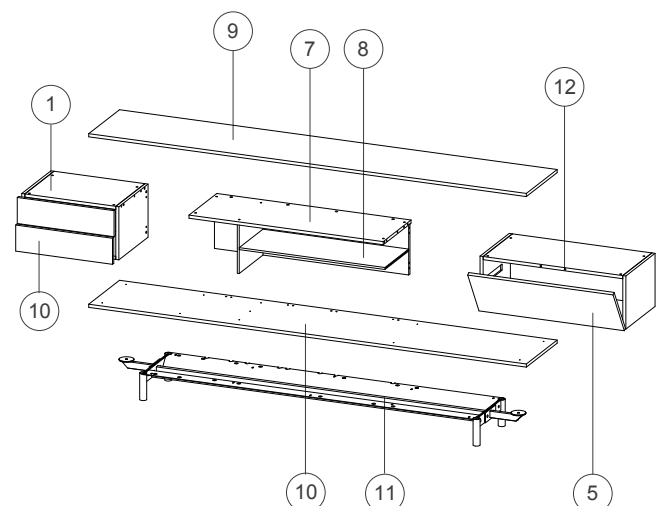
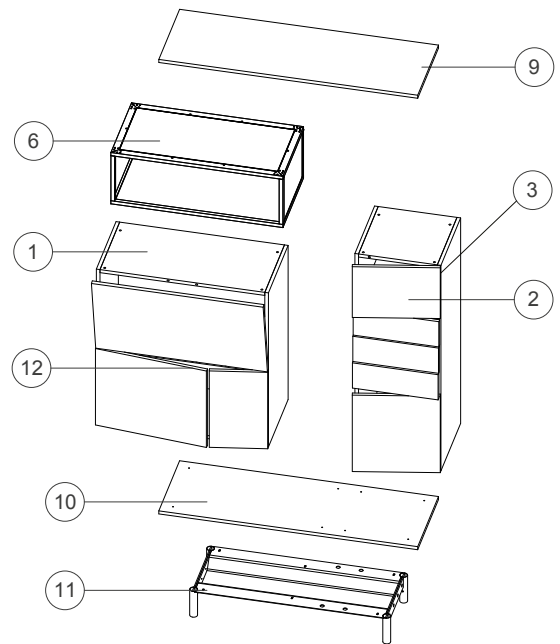

Dimensions

EAS4

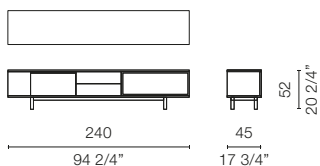

EAS14

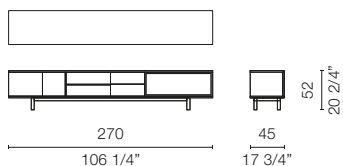

EAS13

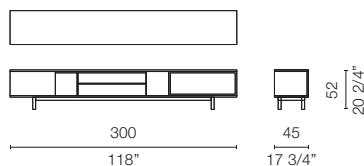

EAS10

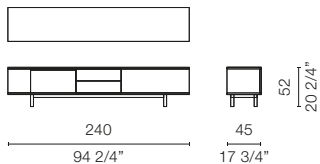

EAS11

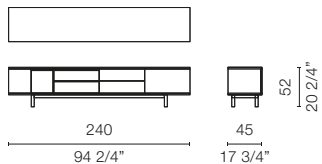

EAS12

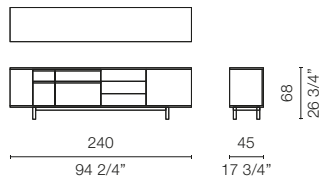

EAS5

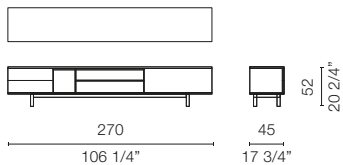

EAS6

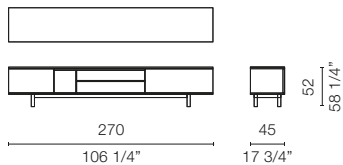

EAS8

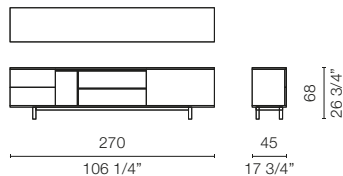

EAS9

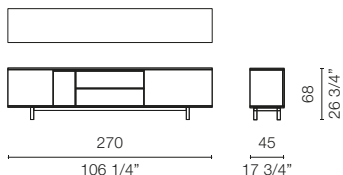

EAS2

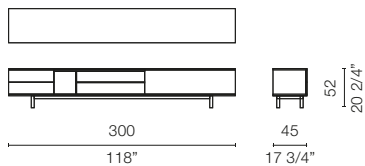

EAS19

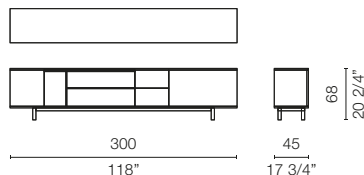

EAS7

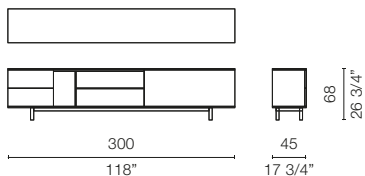

EAS1

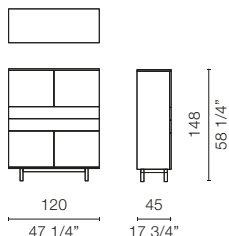

EAS15

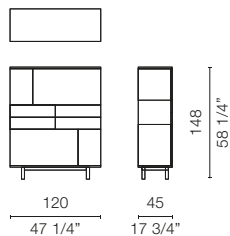

EAS3

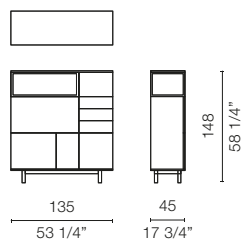

EAS20

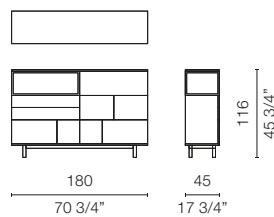

EAS17

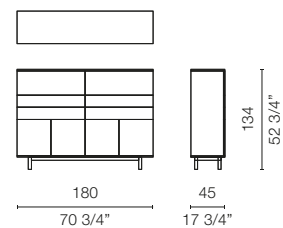

EAS16

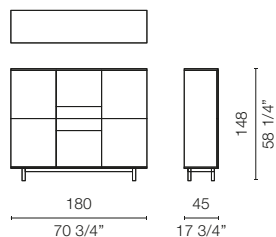

EAS18

