

LOCHNESS CABINET

Piero Lissoni

cappellini



A product family based on the development of Lochness, introduced in 2014. A sideboard with two leaf doors matt lacquered or in natural oak, wengé-stained oak and natural Santos, conceived for living areas and the office; it is available with inner shelves and two inner drawers.

Used materials

Box, flap door, hinged door

1. Wood particles panels clad in medium density melamine, veneered in natural oak, oak stained wengé, natural santos or matt lacquered.

Tray

2. Wood particles panels clad in medium density melamine, veneered or lacquered

Base

3. Metal
Finishing bronze or chrome
Painted in white or anthracite

Feet

4. White plastic

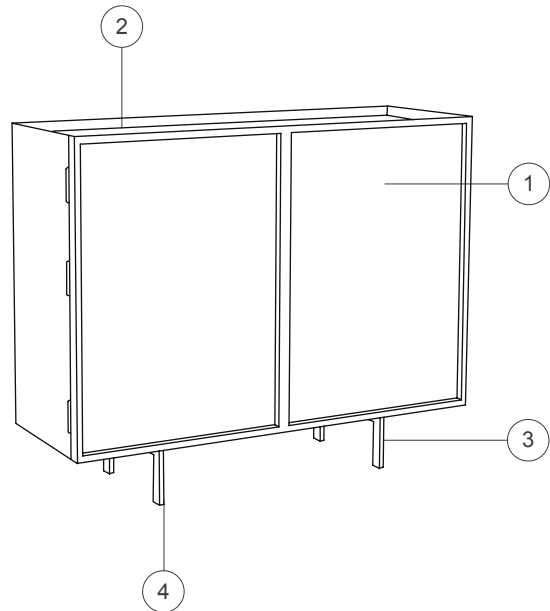

Dimensions

LH_1

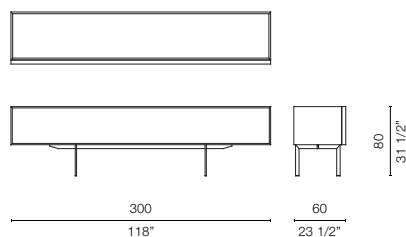

LH_1C

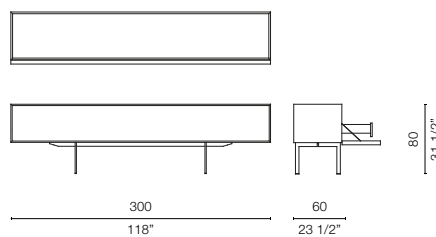

LH_2

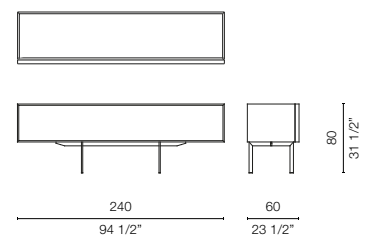

LH_2C

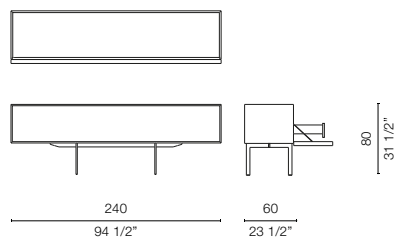

LH_3

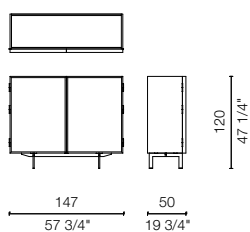

LH_V

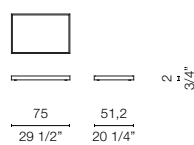

LH_V1

