

LOCHNESS TABLE

Piero Lissoni

cappellini



Tables and writing desk on a metal base to be equipped with and undertop chest of drawers and two drawers, suitable for managerial offices and for private dining rooms. A chest of drawers on casters joins the collection

Used materials

Top and chest of drawers:

1. Medium-density wood particles panels melamine plated, wood veneered, finishing in natural oak, wengè stained oak, natural santos or Canaletto walnut.

Base:

2. Metal finishing in bronze, white, anthracite or polished chromed.

Feet:

3. White plastic

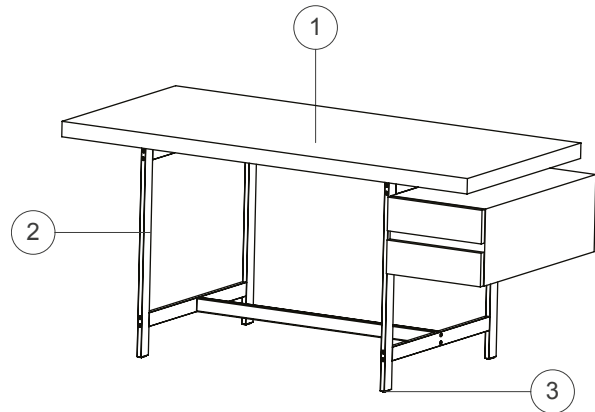

Dimensions

LH_4

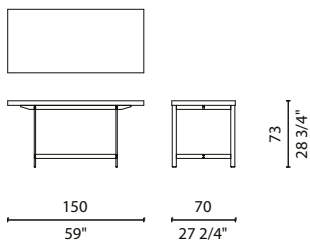

LH_5

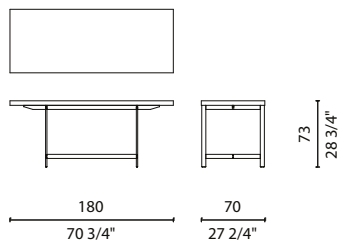

LH_6

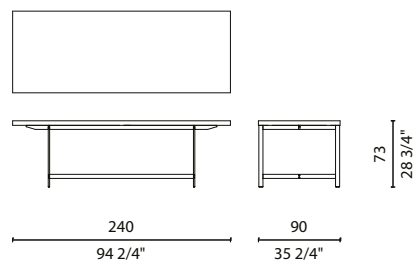

LH_7

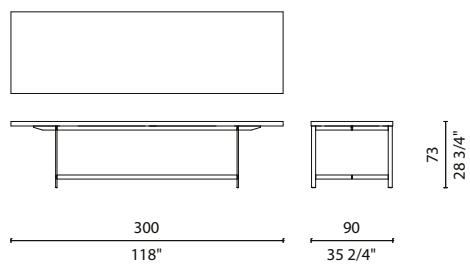

LH_8L

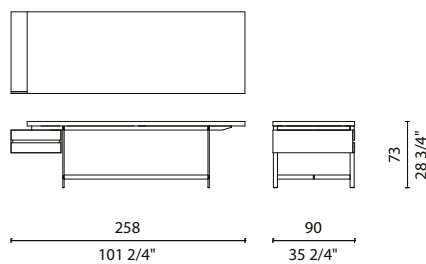

LH_8R

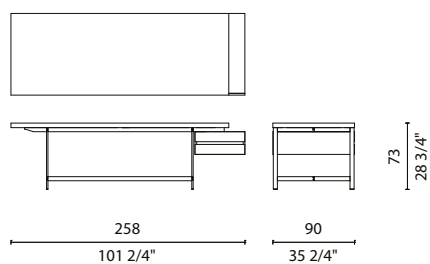

LH_8D

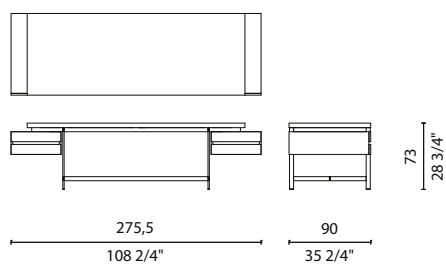

LH_9L

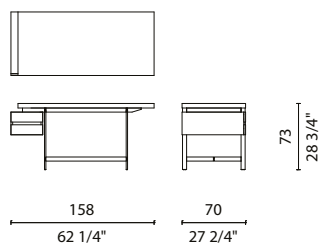

LH_9R

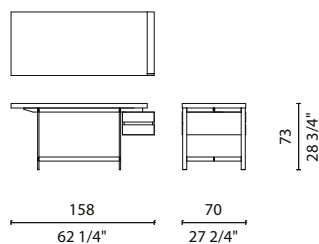

LH_10L

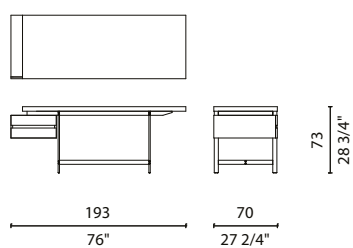

LH_10R

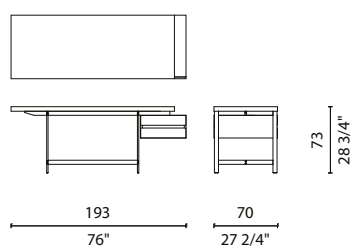

LH_11

