



Series of cabinets suitable both for the living area and for the office, available in matt or polished lacquer; metal base is matt lacquered in the same color as the case. Luxor cabinets are roomy, simple and well-designed down to the smallest detail.

Used materials

Structure:

1. Base metal epoxy powder coated matt lacquer in the colors of the case

Case:

- 2. Case panels made of wood particles veneered melamine matt or glossy colors listed in the price list
- 3. Doors in poplar plywood covered with aluminum matt or glossy colors of the case
- 4. Drawer fronts and shelves in panels mix of medium density fibreboard coated aluminum matt or gloss Case
- 5. Handles made of solid beech matt lacquered in the colors of the case
- 6. Hinges with snap-in steel

Feet:

7. Felt

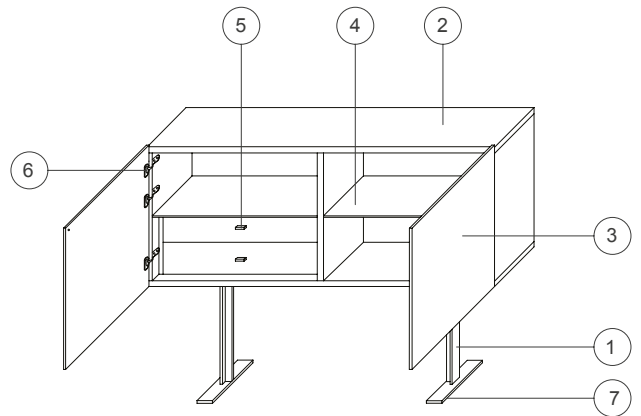

Dimensions

LX_3

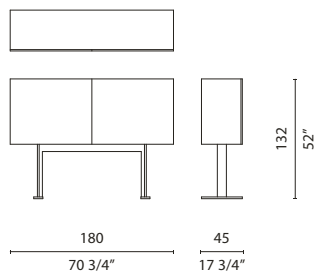

LX_4

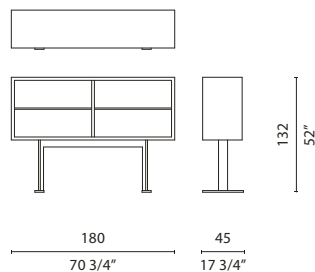

LX_5

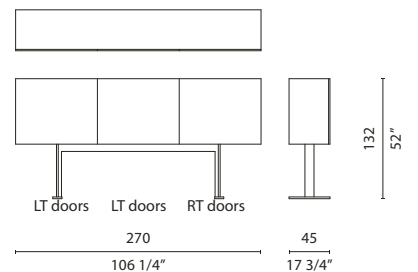

LX_7

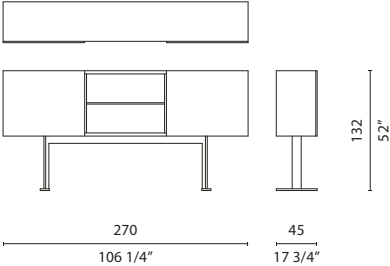

LX_8

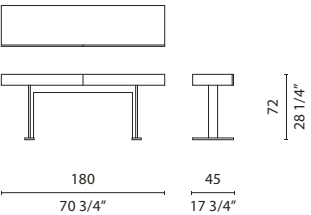

LX_9

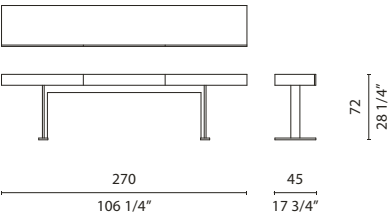

LX_12

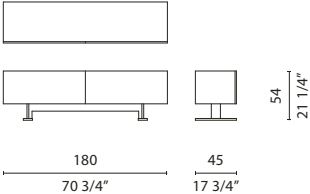

LX_13

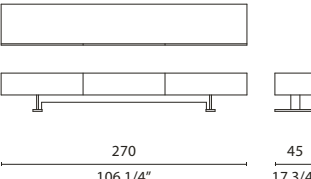

LX_14

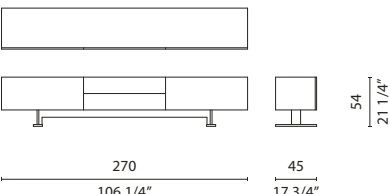

LX_15

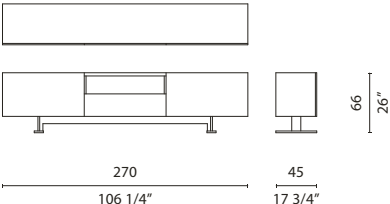

LX_16

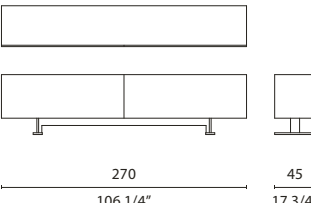

LX_17

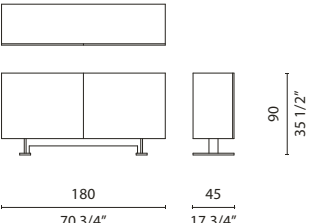

LX_18



LX_19

