

PANDA SOFA

Paola Navone

cappellini



Upholstery collection made up of sofa, central, end, corner units and poufs available in two depths, cm 95 or cm 125 with different widths for a wide combination of seating elements.

Used materials

Structure:

1. Medium density fibre conglomerate panels, solid fir, poplar plywood

Padding:

2. Multi-density polyurethane foam, with removable cover in fabric of the collections, or fixed in leather G, Extra G2.

Feet:

3. Black plastic

Free cushion

Recommended as a completion, made in fiber in the fabrics and leathers from the collection or in patterned fabric "Kiki Red" or "White/Black Splash"

Free cushion cubes

Recommended as a completion, made in foam and fiber in the fabrics and leathers from the collection or in patterned fabric "Kiki Red" or "White/Black Splash"

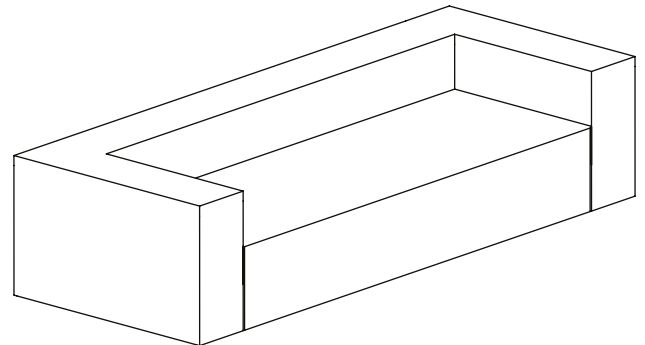

Dimensions

PALR25

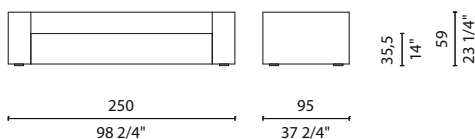
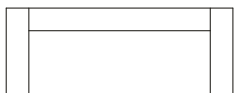

PALR12D / PALR12C

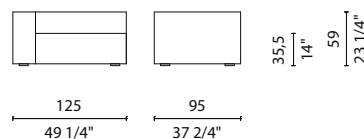

PALR12B / PALR12A

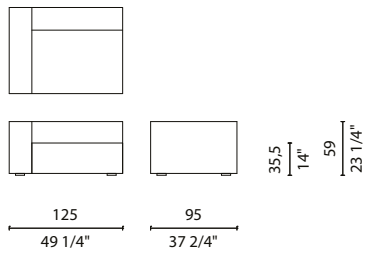

PALR22D / PALR22C

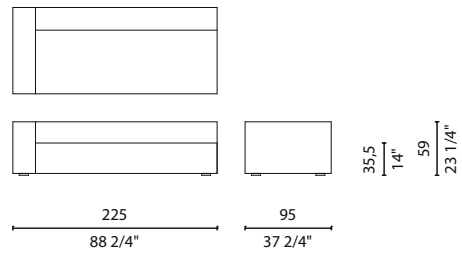

PALR22B / PALR22A

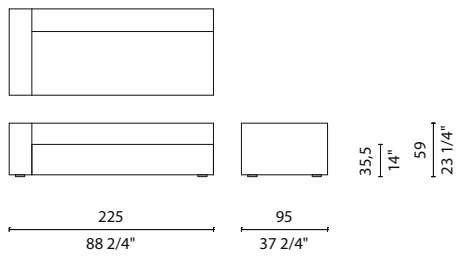

PALR20

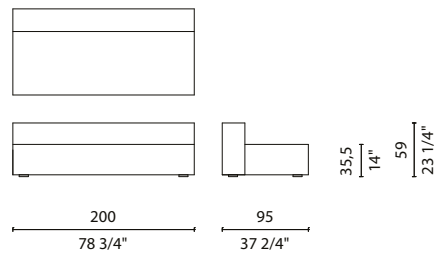

PALR10

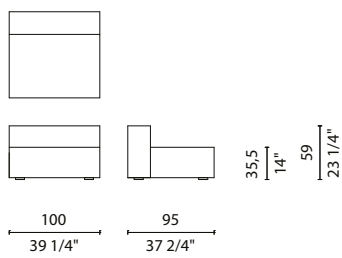

PALR95

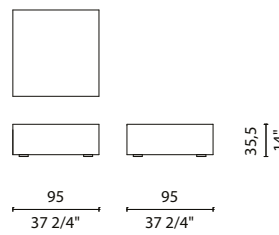

PALR95D / PALR95C

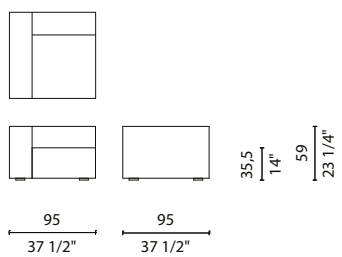

PALR95B / PALR95A

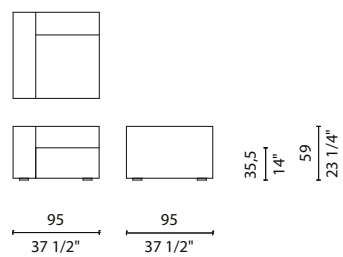

PALX25

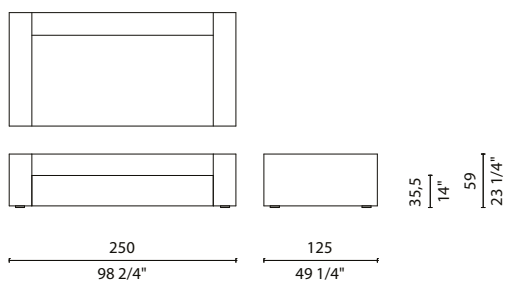

PALX12D / PALX12C

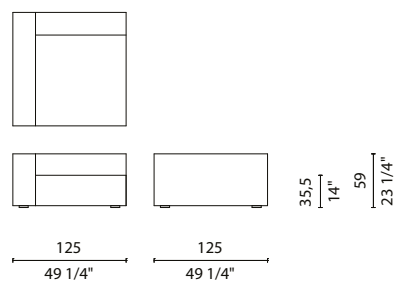

PALX12B / PALX12A

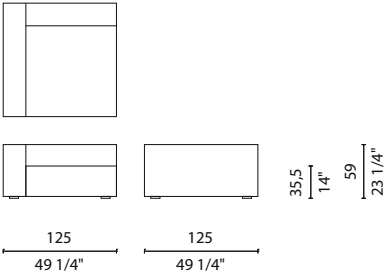

PALX22D / PALX22C

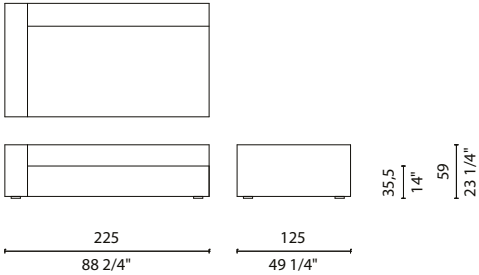

PALX22B / PALX22A

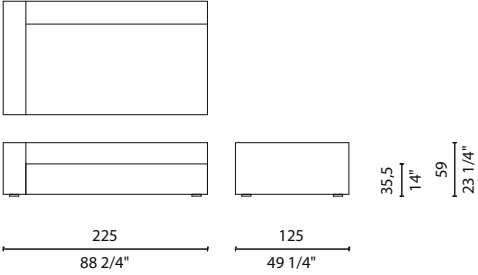

PALX10

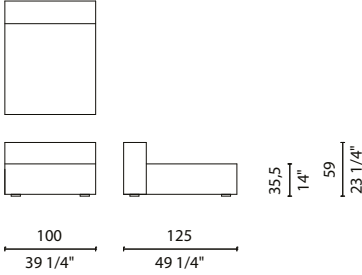

PALX20

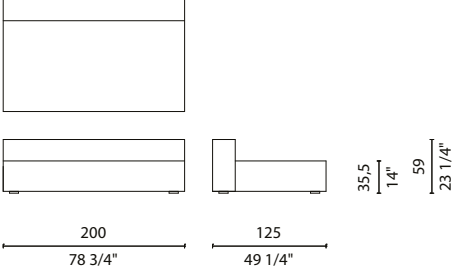

PALX12

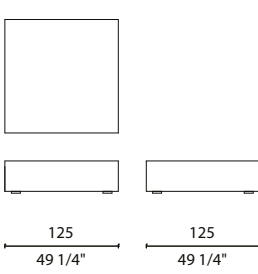

PALX13

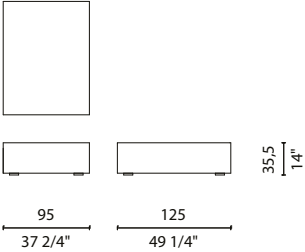

PALC30

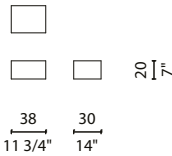

PALC60

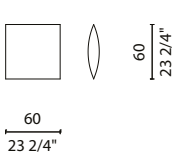

PALC80

