

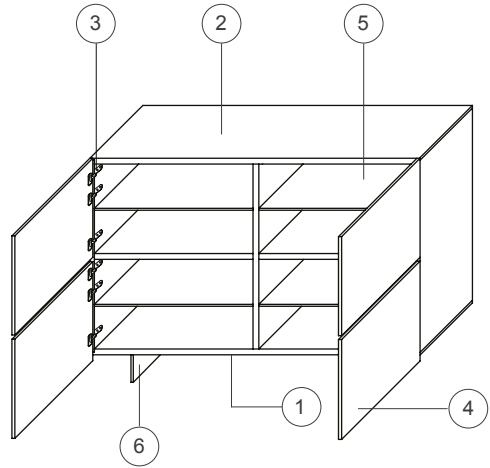

Series of large cabinets in high-density conglomerate panels, available with doors in poplar plywood connected with aluminum and wooden drawers; Uni is available in matt and polish lacquer in all colors of the collection.

Used materials

- Structure:**
 1. Frame in metal powder-coated, matt lacquered in the colors of the case
- Case:**
 2. Panels made of wood particles veneered melamine, matt or glossy colors listed in the price list
 3. Hinges with snap-in steel for movement before doors:
 4. Poplar plywood covered with aluminum, matt or glossy colors of the case
- Shelves:**
 5. Tempered frosted glass
- Feet:**
 6. Feet in thick laminate, matt or glossy colors of the case
- MATERIALS TO APPLY: UN_4B - UN_6 - UN_8



Dimensions

UN_2B

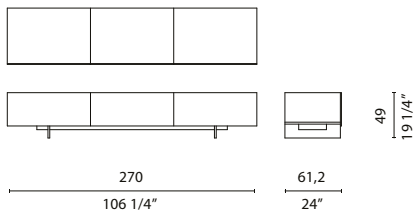

UN_2BQ

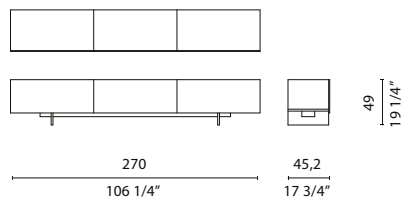

UN_4B

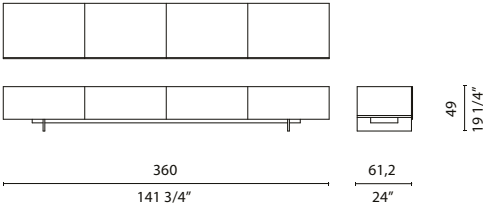

UN_4BQ

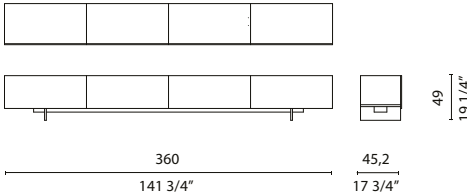

UN_5

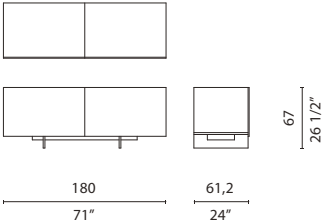

UN_5Q

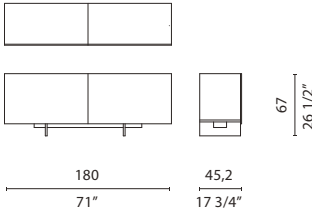

UN_6

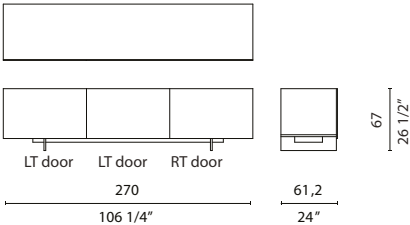

UN_6Q

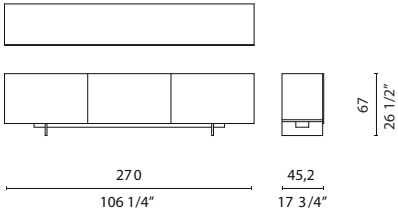

UN_7

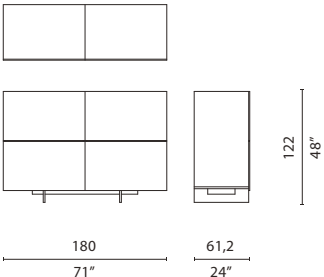

UN_7Q

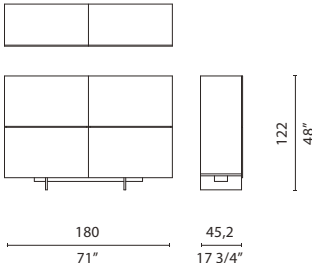

UN_8

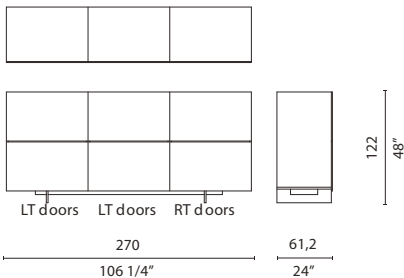

UN_8Q

