

n



a

mega tulip

by  
adam goodrum

naudesign.com.au  
info@naudesign.com.au  
@nau\_design

nau is a contemporary design brand, offering furniture, lighting, and accessories by a collective of Australia's most curious and talented designers.

u

# mega tulip

by Adam Goodrum, 2022

Introducing the next iteration of an Australian classic: Mega Tulip by Adam Goodrum.

Designed for the workplace of tomorrow, Mega Tulip features the same organic curves and perfect proportions as its predecessor, Fat Tulip. Suitable for a plethora of commercial environments ranging from flexible workplaces to lobbies to public areas, Mega Tulip has a distinctive softness that also lends itself to residential settings. Allowing for limitless configurations, Mega Tulip is as adaptable as it is graphically interesting. This flexible modular system is comprised of a diverse landscape of elements, from independent sofas and armchairs, to straight or curved segments and high back booths. Create private zones for focus, open spaces for interaction or casual areas for relaxation.

Available in a wide selection of upholstery options, Mega Tulip is a truly versatile sofa system that offers infinite typologies with one singular design language.

## variations & dimensions

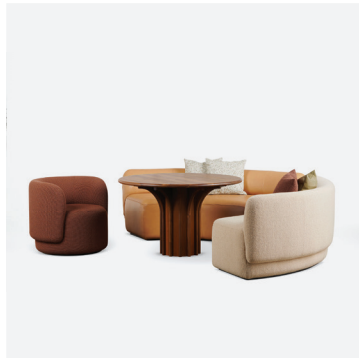

## adam goodrum

A firm believer that every environment is defined by the objects within it, Adam Goodrum designs with the philosophy that an object must therefore justify its existence – through its story and detailing. For this reason, his designs celebrate process and craftsmanship, and accentuate components and joinery to create functional pieces with spirit and personality.

In recent years, Goodrum's work has been awarded a host of design accolades including the NGV Rigg Prize, Vogue x Alessi Design Prize, Indesign Luminary Award and the Idea Awards Editor's Medal. He has also been commissioned to design pieces for several global luxury brands including Veuve Clicquot, Alessi and Cappellini.

n  
a  
u

naudesign.com.au  
info@naudesign.com.au  
@nau\_design

# dimensions - modular

**Mod InsideCurve 1/8 Lowback**  
CU-MT-M-IC-18-LB

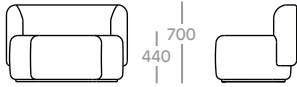
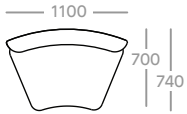

**Mod InsideCurve 1/4 Lowback**  
CU-MT-M-IC-14-LB

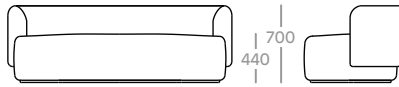
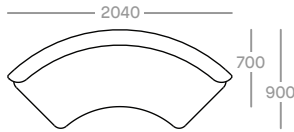

**Mod OutsideCurve 1/4 Lowback**  
CU-MT-M-OC-14-LB

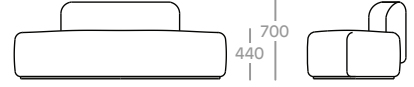
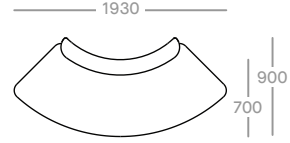

**Mod InsideCurve 1/8 Highback**  
CU-MT-M-IC-18-HB

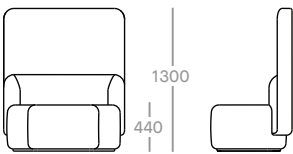
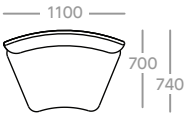

**Mod InsideCurve 1/4 Highback**  
CU-MT-M-IC-14-HB

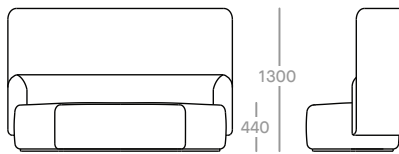
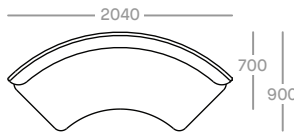

**Mod OutsideCurve 1/4 Highback**  
CU-MT-M-OC-14-HB

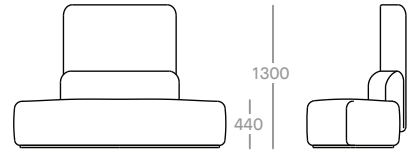
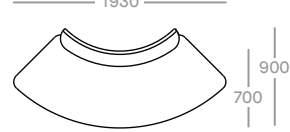

**Mod Round Chaise Left Back**  
CU-MT-M-RC-L

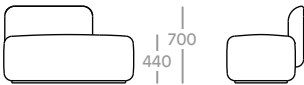
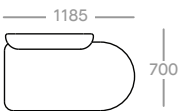

**Mod Round Chaise Right Back**  
CU-MT-M-RC-R

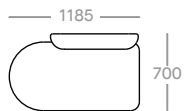

**Mod Square Centre Low Back**  
CU-MT-M-SQ-LB

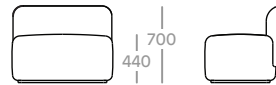
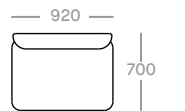

**Mod Square Ottoman**  
CU-MT-M-SQ-O



**Mod Square Chaise Right Back**  
CU-MT-M-SQC-R

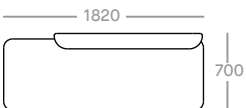

**Mod Square Chaise Left Back**  
CU-MT-M-SQC-L

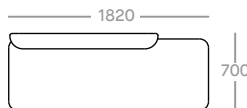

**Mod Corner Low Back**  
CU-MT-M-CR-LB

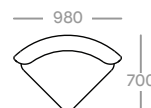

n  
a  
u

# dimensions - singular

**Single Armchair Low Back**  
CU-MT-1S-LB

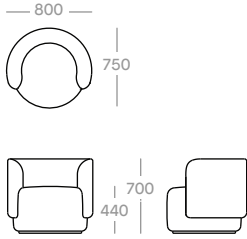

**2 Seater Sofa Low Back**  
CU-MT-2S-LB

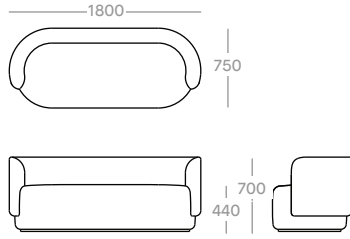

**3 Seater Sofa Low Back**  
CU-MT-3S-LB

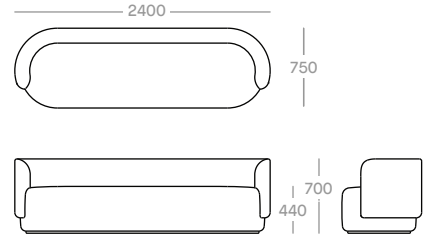

**Single Armchair High Back**  
CU-MT-1S-HB

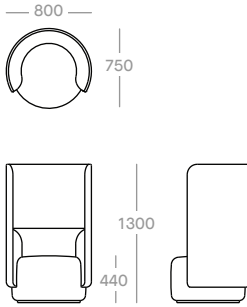

**2 Seater Sofa High Back**  
CU-MT-2S-HB

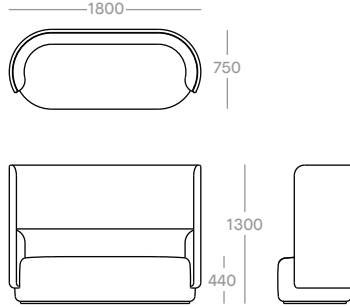

**3 Seater Sofa High Back**  
CU-MT-3S-HB

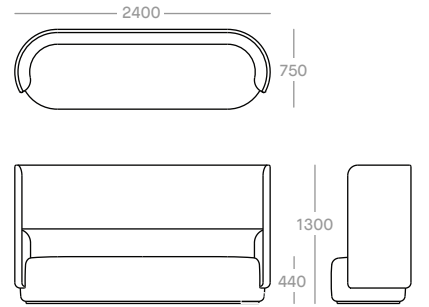

**Single Ottoman**  
CU-MT-1S-O

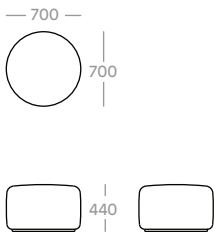

**2 Seater Ottoman**  
CU-MT-2S-O

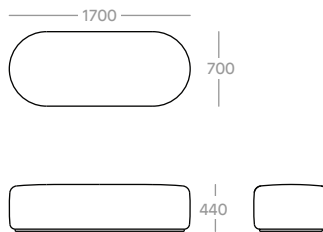

**3 Seater Ottoman**  
CU-MT-3S-O

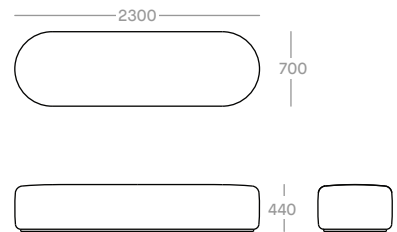

# dimensions - singular

**2 Seater Curved Sofa**  
CU-MT-2S-C

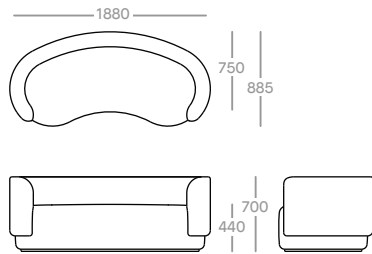

**3 Seater Curved Sofa**  
CU-MT-3S-C

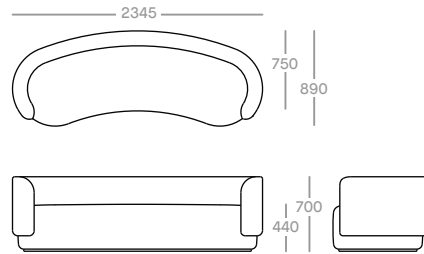

**2 Seater Curved Arm Left**  
CU-MT-2S-CA-L

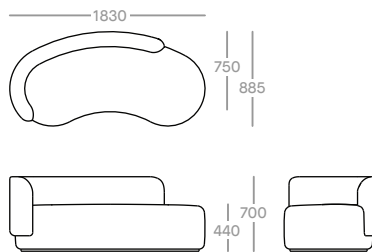

**3 Seater Curved Arm Left**  
CU-MT-3S-CA-L

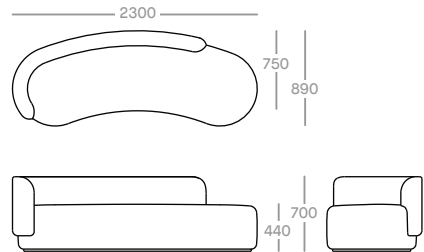

**2 Seater Curved Arm Right**  
CU-MT-2S-CA-R

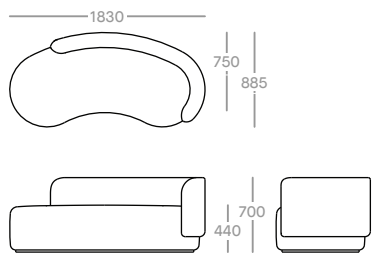

**3 Seater Curved Arm Right**  
CU-MT-3S-CA-R

