



## String® Pocket

String® Pocket is sold as a complete shelf but is equally flexible as String® System. String® Pocket invites creativity and personality where you can combine two or three String® Pocket shelves into one larger shelf. Mix and match different colours and wooden alternatives to suit your style and preferences. Since the shelf is neat and practical it fits equally well as a nightstand as an extra shelf in your hallway.

### About the designers – Nisse and Kajsa Strinning

Nisse Strinning, designer of the String® System, was a Swedish architect born in 1917 in the northern part of Sweden. Nisse designed the first String® shelf in 1949 with great help of his wife, Kajsa Strinning. The couple met while studying at the Royal Institute of Technology in Stockholm. It all started when the Swedish publishing house, Bonniers, announced a competition where they were looking for the perfect shelf. High in functionality, modern design and at a fair price. String® was selected the winner and is considered a Swedish design icon every since.

### Product dimensions

W: 60 cm H: 50 cm D: 15 cm

### Package dimensions

W: 62 cm H: 9 cm D: 17 cm

Weight: 4,5 kg

Transported flat-packed, assembly needed.

### Weight recommendation

25 kg evenly spread across one shelf.

### Materials and colors

Panels in powder coated steel.

Shelves in either veneer or lacquer.

Brackets in zinc.

### Production

Made in Sweden.









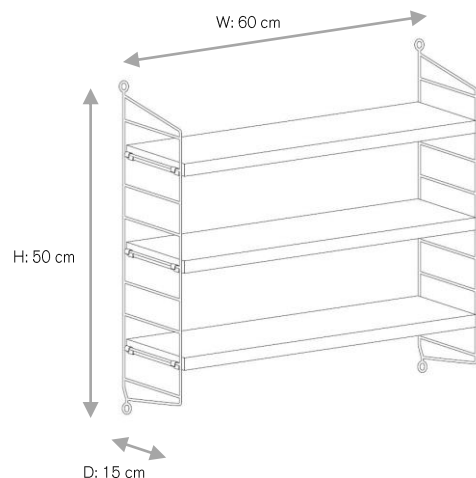



### Sustainability

The panels are powder coated and made from 100% recycled material and can be recycled. The shelves are made from the renewable and recyclable material wood. The included brackets are made from zinc, which can be recycled and used again and again.

### Care and maintenance

Wipe the surface with a cloth. Damp wipe with detergent solution. Then rub dry with a cloth. Remove stains with detergents that do not contain abrasives. Never use steel wool.



	White NCS S 0500-N / RAL 9016
	Grey NCS S 4500-N / RAL 7004
	Green NCS S 2070-G10Y – New 2023
	Purple NCS S 3050-R60B – New 2023
	 Oak / White RAL 9016
	 Ash / White RAL 9016
	 Walnut / Black RAL 9005
	 Black stained ash / Black RAL 9005

